

# INFORMATION

## IC-705 Version 1.20

The following features are now changed in, or added to, the IC-705.

- Added** : New functions and/or menus have been added.
- Changed** : Some operations, items, and/or options that already exist have been changed.

<ul style="list-style-type: none"> <li><b>Changed</b> Scope operation..... 1</li> <li><b>Added</b> PRESET menu ..... 2</li> <li><b>Added</b> About an antenna tuner ..... 3</li> <li><b>Added</b> WLAN (Access point) operation ..... 4</li> <li><b>Added</b> Custom key on the front panel ..... 5</li> <li><b>Changed</b> Remote MIC key and VS-3's Custom key functions ..... 6</li> </ul>	<ul style="list-style-type: none"> <li><b>Changed</b> Set mode..... 6</li> <li><b>Changed</b> Latitude/Longitude unit ..... 7</li> <li><b>Changed</b> Tone Control settings in the Data mode..... 7</li> <li><b>Changed</b> CI-V commands ..... 8</li> </ul>
---	--

### Changed Scope operation

- The Scroll mode is added.
- When the scope span or Edge frequency is changed, such as by touching [SPAN] or [EDGE], the selected scope span or the selected Edge frequency display is enlarged.
- In the SCOPE SET menu, “Marker Position (FIX Type)” is renamed to “Marker Position (FIX Type/ SCROLL Type).”
- The maximum number of Fixed Edges for each band is increased from 3 to 4.

### ◇ Scroll mode

Displays signals within a selected span. When the operating frequency moves outside of the screen, the displayed frequency range is automatically scrolled.

1. Display the SPECTRUM SCOPE screen.  
MENU » SCOPE
2. Touch [CENT/FIX] for 1 second to select the Scroll mode.
  - When changing the Center mode to the Scroll mode, “SCROLL-C” is displayed.
  - You can change the scope span by touching [SPAN].
  - When changing the Fixed mode to the Scroll mode, “SCROLL-F” is displayed.
  - You can change the Edge frequencies by touching [EDGE].
3. Touch [CENT/FIX] to return to the previous mode.
  - When returning to the Center mode, the scope span does not return to the previous setting.
  - When returning to the Fixed mode, the Edge frequencies return to the last selected “Fixed Edges.”

If the operating frequency is above the upper Edge frequency, or below the lower Edge frequency, “<<” or “>>” is displayed in the upper side corners of the SPECTRUM SCOPE screen.

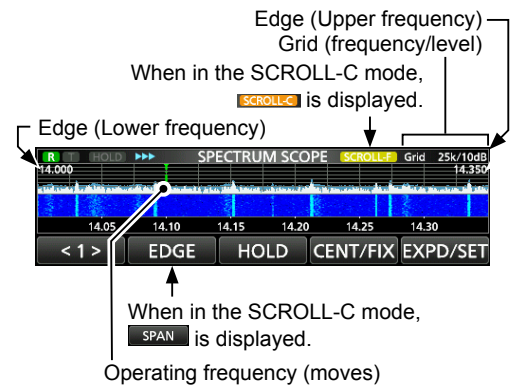

## Added PRESET menu

[PRESET] is added to the MENU screen.

You can save the combination of the following settings for the data mode to quickly change the settings, depending on your operating needs.

Preset Name	SSB-D TX Bandwidth
Mode	DATA OFF MOD
Filter	COMP
Filter BW	SSB TBW
Filter Type (HF)	SSB TX Bandwidth
Filter Type (50M - )	USB SEND
USB Output Select	USB Keying (CW)
USB AF Output Level	USB Keying (RTTY)
USB AF SQL	CI-V Address
USB IF Output Level	CI-V Transceive
USB MOD Level	CI-V USB Echo Back
DATA MOD	

① The transceiver has a total of 5 memories.

### ◇ Loading the preset memory

1. Push **[MENU]**.
2. Touch ② at the center bottom of the screen.
3. Touch **[PRESET]**.



4. Touch the preset memory to load.
  5. Touch **[YES]**.
    - The selected preset memory is loaded, and "In Use" is displayed on the PRESET screen. If you change the transceiver settings, and they do not match the contents of the preset memory, "In Use" disappears.
- ① Touching **[UNLOAD]** returns the transceiver settings to those set before loading the preset memory.

**NOTE:** You cannot load the preset memory content when:

- You select a blank memory.
- Transmitting in the DV mode.
- The DR function is ON.
- The DV Gateway function is ON.
- The transceiver is in the WX mode. (For only the USA version)

### ◇ Editing the memory contents

**NOTE:** You cannot edit the preset memory that is in use. To edit it, first touch **[UNLOAD]**, and then edit the memory.

1. On the PRESET screen, touch a preset memory to edit for 1 second.
  - Opens the QUICK MENU screen.
2. Touch "Edit the Preset Memory."
  - ① When touching "Save to the Preset Memory," all of the contents are set to the current settings before editing.
3. Touch the check box to select whether or not to load the item.
  - "✓" is displayed on the left side of the loading item.
4. Touch the item name, and then touch the option to set.
5. Repeat steps 3 and 4 to edit the preset memory.
6. Touch "<<Write>>."
7. Touch **[YES]**.

**TIP:** Depending on your software, you may need to change the "CI-V Address" setting. For example, you use a software that is not compatible with the IC-705. In that case, you may be able to use the software by setting "CI-V Address" to another transceiver's address.

## Added About an antenna tuner

The optional AH-705 AUTOMATIC ANTENNA TUNER can also match the IC-705 to a long wire antenna.

- 1.8 MHz band:  
with an antenna longer than 30 m, 98.4 ft
  - 3.5 MHz band and above:  
with an antenna longer than 7 m, 23 ft
- ① See the AH-705 instruction manual for installation and connection details.
- ① When you use a non-Icom external antenna tuner, see the antenna tuner's instruction manual for details.

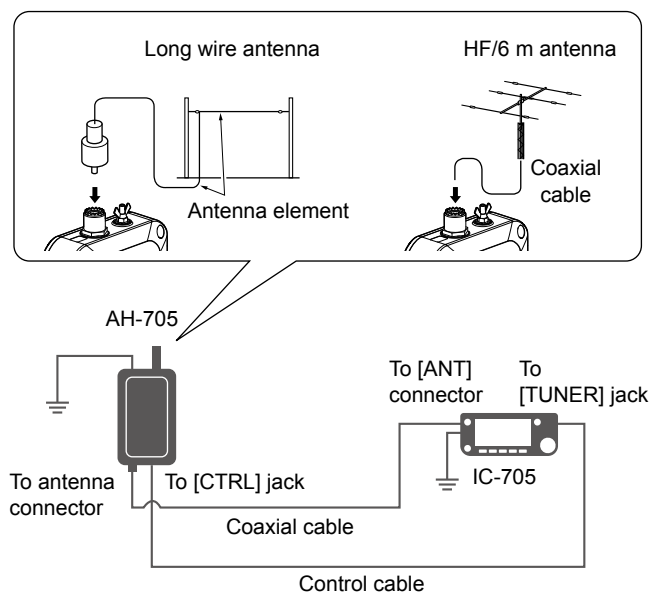

**⚠ DANGER HIGH VOLTAGE! NEVER** touch the antenna element while tuning or transmitting. Always install the antenna element in a secure place.

### NOTE:

- Before connecting the cables, be sure to turn OFF the transceiver.
- **NEVER** use the antenna tuner without an antenna connected. The tuner and transceiver will be damaged.
- When a wire antenna cannot be tuned, check the wire length and connection.  
The AH-705 cannot tune a wire that is a  $\frac{1}{2}\lambda$  long or on a multiple of that frequency.
- The AH-705 uses latching relays with low power consumption. The latching relays themselves memorize the operating state, but they may not hold the settings after a strong impact to the tuner. If the SWR significantly changes during operation, retune the antenna.

### ◇ Using the antenna tuner

- ① The [TUNER] button operation to turn the antenna tuner ON or OFF in the FUNCTION screen is changed from touching for 1 second to touching briefly.
  1. Connect the tuner to the transceiver.
  2. Turn ON the transceiver.
  3. Select the desired operating frequency.
  4. Push **FUNCTION**.
  5. Touch ② at the center bottom of the screen.
  6. Touch [TUNER].
    - The transceiver automatically starts transmitting and tuning. The tuner reduces the SWR to less than 2:1 after 2 ~ 3 seconds of tuning.
    - ① While tuning, a side tone is heard, and "TUNE" blinks.
    - ① Touching [TUNER] turns the antenna tuner ON or OFF (bypassed).
  7. After tuning, "TUNE" is displayed.
    - ① If the tuner cannot reduce the SWR to less than 2:1 after 15 seconds of tuning, the indicator goes out.
    - ① When a long wire antenna cannot be tuned, the indicator goes out. In that case, the tuner is bypassed, and the wire is directly connected.
    - ① To manually tune the antenna, touch [TUNER] for 1 second.

### ◇ PTT tune function

The PTT tune function activates the "tune" function when the transceiver is transmitting on a new frequency.\*

This function can be set to ON or OFF. (Default: ON)

**MENU** » **SET > Function > Tuner > PTT Start**

- \* 1.8 ~ 10 MHz band: Changed more than 0.5%
- 14 ~ 50 MHz band: Changed more than 1%

**TIP:** Even if the tuner cannot tune the antenna on the first attempt, it may succeed by repeating the tuning several times.

### ◇ Tune memory function

The Tune Memory function saves the latching relay combination for quicker antenna tuning.

This function can be set to ON or OFF. (Default: ON)

**MENU** » **SET > Function > Tuner > AH-705 > Tune Memory**

- ① If the Tune Memory function is OFF, it may take more time to tune the antenna, but the SWR may become a lower value.
- ① To clear the memories, select "<<Tune Memory Clear>>".

**MENU** » **SET > Function > Tuner > AH-705 > <<Tune Memory Clear>>**

**TIP:** If the operating environment is changed, such as changing the length of the wire antenna, clearing the memories may make tuning quicker.

**Added** About an antenna tuner

## ◇ Updating the AH-705's firmware

You can update the AH-705's firmware by using the transceiver. And to use this function, an "AH-705" folder is added on the microSD card.

① If you have already formatted your microSD card using the earlier version transceiver, inserting the microSD card into the transceiver (version 1.20 or later) automatically creates the AH-705 folder in the IC-705 folder.

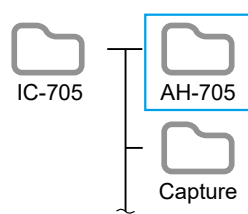

- **AH-705 folder**  
The AH-705's firmware data in the "dat" format

**IMPORTANT:** To update the firmware, first format your microSD card using the IC-705.

**CAUTION: NEVER** turn OFF either the transceiver or the antenna tuner, or disconnect the cables while updating the firmware. If you turn OFF the transceiver or the antenna tuner, or disconnect the cables, or if a power failure occurs while updating, the antenna tuner's firmware will be damaged, and you will have to send the tuner back to the nearest Icom distributor for repair. This type of repair is out of warranty, even if the tuner warranty period is still valid.

### Recommendation!

Fully charging of the transceiver's battery pack and attaching the batteries with sufficient capacity to the antenna tuner before starting the firmware update, or using the external power source is strongly recommended.

This is to avoid failure during the update, caused by an unexpected power failure.

1. Access the following URL and download the firmware file.  
<https://www.icomjapan.com/support/>
2. Unzip the downloaded firmware folder.
3. Copy the firmware data into the "IC-705" > "AH-705" folder on to a microSD card.
4. Insert the microSD card into the transceiver.
5. Display the FIRMWARE UPDATE (AH-705) screen.  
**MENU** » **SET > SD Card > Firmware Update (AH-705)**
6. After you read and agree with all the precautions, touch [YES].
7. Touch the firmware file.
8. After you read and agree with all the precautions, touch [YES] for 1 second.
9. When the update is completed, "Firmware updating has completed." is displayed in the dialog.
  - The transceiver and the antenna tuner will automatically restart.

## **Added** WLAN (Access point) operation

You can use the transceiver as a Wireless LAN (WLAN) access point. When turning ON the WLAN (Access point) function, your PC or mobile device can directly connect to the transceiver for:

- Outputting the demodulated AF signal or 12 kHz IF signal, by using the optional RS-BA1's Remote Utility.
  - ① You can set the output signal to AF or IF signals.

**MENU** » **SET > Connectors > WLAN AF/IF Output > Output Select**

- Remote control using the optional RS-BA1 software application.
- Transferring pictures from a PC or a mobile device.

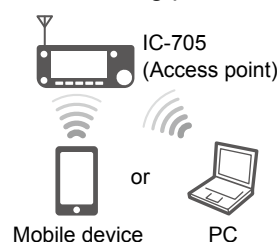

① Only one device can connect to the transceiver at the same time.

**NOTE:** You cannot connect to the Internet through the IC-705.

## ◇ Connecting a device to a transceiver (Access point)

### Step 1. Setting the "WLAN set" items (Transceiver)

Before using the WLAN (Access point) function for the first time, you must set a password.

1. Turn OFF the WLAN function.  
**MENU** » **SET > WLAN Set > WLAN**
2. Set "Connection Type" to "Access Point (Connect to Phone, PC)."  
**MENU** » **SET > WLAN Set > Connection Type**
3. Open the CONNECTION SETTINGS (ACCESS POINT) screen, and set each item.  
**MENU** » **SET > WLAN Set > Connection Settings (Access Point)**
  - ① See page 7 for each item's details.
  - ① You must set "Password."
4. Turn ON the WLAN function.
  - While the WLAN (Access point) function is ON,  is displayed.
  - ① If no device connects to the transceiver during the set period of time in the "Inactivity WLAN OFF Timer," the WLAN function is turned OFF. (Default: 20min)
  - ① Once you set a password, you do not need to turn OFF the WLAN function to change "Connection Type."

### Step 2. Connecting to the transceiver (PC, mobile device)

1. Turn ON the WLAN function.
2. Select the transceiver's SSID from the network list. (Default: IC-705)
3. If a password is required, enter the password.

## Added Custom key on the front panel

You can change the **VOX** / **BK-IN** and **AUTOTUNE/RX>CS** keys function.

**MENU** » **SET > Function > Front Key Customize**

**[VOX/BK-IN]** (Default: VOX/BK-IN)

Function	Description
TRANSMIT	Push to toggle between transmit and receive.
TUNER	<ul style="list-style-type: none"> <li>• Push to turn the antenna tuner ON or OFF.</li> <li>• While "TUNE" is displayed, hold down for 1 second to start manual tuning.</li> </ul>
VOX/BK-IN*	Push to turn the VOX function in the Voice operation modes and the Break-in function in the CW mode ON or OFF.
P.AMP/ATT	<ul style="list-style-type: none"> <li>• Push to turn ON or OFF, and select one of two receive RF preamplifiers.</li> <li>• In the HF or 50 MHz band, hold down for 1 second to turn the Attenuator ON or OFF.</li> </ul>
NOTCH*	Push to turn the Notch function ON or OFF, and select the Notch function type.
NB*	Push to turn the Noise Blanker ON or OFF.
NR*	Push to turn the Noise Reduction function ON or OFF.
SPLIT	<ul style="list-style-type: none"> <li>• Push to turn the Split function ON or OFF.</li> <li>• Hold down for 1 second to turn ON the Quick Split function.</li> </ul>
A/B	<ul style="list-style-type: none"> <li>• Push to select the VFO A or VFO B.</li> <li>• Hold down for 1 second to set the displayed VFO's frequency to the VFO that is not displayed.</li> </ul>
VFO/MEMO	<ul style="list-style-type: none"> <li>• Push to select the VFO mode and the Memory mode.</li> <li>• Hold down for 1 second to copy the Memory channel contents to the VFO.</li> </ul>
CD	Push to open the received call history.
PRESET	Push to open the PRESET screen.

**[AUTOTUNE/RX>CS]** (Default: AUTOTUNE/RX>CS)

Function	Description
AUTOTUNE/ RX>CS	<p><b>In the CW mode</b> Push to automatically tune the operating frequency to a close-by CW signal.</p> <p><b>In the DV mode</b></p> <ul style="list-style-type: none"> <li>• Push to display the RX History list.</li> <li>• Hold down for 1 second to capture the latest received call sign (station or repeater) as a temporary call destination.</li> </ul>
CD/ RX>CS	<ul style="list-style-type: none"> <li>• Push to open the received call history.</li> <li>• In the DV mode, hold down for 1 second to display the RX History list.</li> </ul>
PRESET/ RX>CS	<ul style="list-style-type: none"> <li>• Push to open the PRESET screen.</li> <li>• In the DV mode, hold down for 1 second to display the RX History list.</li> </ul>

Function	Description
Home CH	<p>Push to directly select the Home Channel that is set to the selected mode (VFO/Memory) or DR screen.</p> <p>① While in the Call channel mode, or when no Home CH is set, an error beep sounds.</p>
Temporary Skip	Push to set the frequency to be skipped while scanning. The selected frequencies are temporarily skipped for faster scanning.
Voice/ Keyer/ RTTY Memory 1	<p><b>In the SSB, AM, FM, or DV mode</b></p> <ul style="list-style-type: none"> <li>• Push to transmit the voice audio recorded on the microSD card once.</li> <li>• Hold down for 1 second to repeatedly transmit the voice audio.</li> </ul> <p>① This key function can also be used on the DR screen.</p> <p>① If the voice audio is not saved in the Voice TX memory (T1 ~ T4), this function is disabled.</p>
Voice/ Keyer/ RTTY Memory 2	<p><b>In the CW mode</b></p> <ul style="list-style-type: none"> <li>• Push to transmit the Keyer memory content once.</li> <li>• Hold down for 1 second to repeatedly transmit the memory content.</li> </ul> <p>① If the Keyer memory content (M1 ~ M4) is not entered, this function is disabled.</p>
Voice/ Keyer/ RTTY Memory 3	<p><b>In the RTTY mode</b> Push to transmit the RTTY memory content once.</p> <p>① If the RTTY memory content (RT1 ~ RT4) is not entered, this function is disabled.</p>
Voice/ Keyer/ RTTY Memory 4	

\* Hold down for 1 second to open its function menu.

Function	Description
Home CH/ RX>CS	<ul style="list-style-type: none"> <li>• Push to directly select the Home Channel that is set to the selected mode (VFO/Memory) or DR screen.</li> <li>① While in the Call channel mode, or when no Home CH is set, an error beep sounds.</li> <li>• In the DV mode, hold down for 1 second to display the RX History list.</li> </ul>
Temporary Skip/ RX>CS	<ul style="list-style-type: none"> <li>• Push to set the frequency to be skipped while scanning. The selected frequencies are temporarily skipped for faster scanning.</li> <li>• In the DV mode, hold down for 1 second to display the RX History list.</li> </ul>

## Changed Remote MIC key and VS-3's Custom key functions

The assignable functions are changed, or added.

- “Voice TX” (T1/T2) and “Keyer Memory” (M1/M2) are changed to “Voice/Keyer/RTTY Memory” (1 ~ 4).
- “TUNER” is added.

**MENU** » SET > Function > **Remote MIC Key**

**MENU** » SET > Bluetooth Set > Headset Set > Icom Headset > **Custom Key**

Function	Description
Voice/Keyer/RTTY Memory 1	<p><b>In the SSB, AM, FM, or DV mode</b></p> <ul style="list-style-type: none"> <li>• Push to transmit the voice audio recorded on the microSD card once.</li> <li>• Hold down for 1 second to repeatedly transmit the voice audio.</li> </ul> <p>① This key function can also be used on the DR screen.</p>
Voice/Keyer/RTTY Memory 2	<p>① If the voice audio is not saved in the Voice TX memory (T1 ~ T4), this function is disabled.</p> <p><b>In the CW mode</b></p> <ul style="list-style-type: none"> <li>• Push to transmit the Keyer memory content once.</li> <li>• Hold down for 1 second to repeatedly transmit the memory content.</li> </ul> <p>① If the Keyer memory content (M1 ~ M4) is not entered, this function is disabled.</p>
Voice/Keyer/RTTY Memory 3	<p><b>In the RTTY mode</b></p> <p>Push to transmit the RTTY memory content once.</p> <p>① If the RTTY memory content (RT1 ~ RT4) is not entered, this function is disabled.</p>
Voice/Keyer/RTTY Memory 4	<p>Push to transmit the RTTY memory content once.</p> <p>① If the RTTY memory content (RT1 ~ RT4) is not entered, this function is disabled.</p>
TUNER	<ul style="list-style-type: none"> <li>• Push to turn the antenna tuner ON or OFF.</li> <li>• While “TUNE” is displayed, hold down for 1 second to start manual tuning.</li> </ul>

**NOTE:** If you set any keys to “Voice TX” (T1/T2) or “Keyer Memory” (M1/M2), they are automatically changed to the “Voice/Keyer/RTTY Memory” (1/2) after updating. Note that these keys work in almost all modes.

## Changed Set mode

**NOTE:** The “Battery Pack Confirmation” item is returned to “OFF” after updating.

**MENU** » SET > Function > **Battery Pack Confirmation**

### ◇ Function

The “Tuner” item is added.

**MENU** » SET > Function > **Tuner**

“Tuner (PTT Start)” is renamed to “PTT Start,” and moved into the “Tuner” item. The “Tuner Select” and “AH-705” settings are added to the “Tuner” item.

#### Tuner Select (Default: AH-705)

Selects the antenna tuner type to be connected.

① To use the Tune Memory function, select “AH-705.”

① When this item is set to “AH-705,” the transmit power is set to 5 watts while tuning, regardless of the transmit power setting.

**MENU** » SET > Function > Tuner > **AH-705**

#### Tune Memory (Default: ON)

Selects whether or not to use the Tune Memory function. The Tune Memory function saves the latching relay combination for quicker antenna tuning.

① To use the Tune Memory function, set “Tuner Select” to “AH-705.”

#### <<Tune Memory Clear>>

Clears all of the antenna tuner’s tune memories.

### ◇ Time Set

**MENU** » SET > Time Set > **Date/Time**

#### Date

The settable range is changed to between 2020/01/01 and 2099/12/31.

Changed Set mode

## ◇WLAN Set

The “Connection Type” item is added.  
Depending on the “Connection Type” setting, “Connection Settings” is changed to “Connection Settings (Station)” or “Connection Settings (Access Point).”

- ① The settings in “Connection Settings (Station)” are the same as in the previous “Connection Settings.”
- ① The maximum number of characters in the Password setting is decreased from 64 to 63 characters.

**MENU** » **SET > WLAN Set**

### Connection Type

(Default: Station (Connect to Network))

Selects the WLAN connection type.

- Station (Connect to Network):  
Sets to connect to the network.
- Access Point (Connect to Phone, PC):  
Sets to directly connect to a mobile device.

**MENU** » **SET > WLAN Set > Connection Settings (Access Point)**

### SSID (Default: IC-705)

Enter an SSID of up to 32 characters.

- ① You cannot change this setting while the WLAN function is ON.

### Password

Enter a password to connect to the transceiver from another device.

- ① The password should be 8 ~ 63 characters long.
- ① You cannot change this setting while the WLAN function is ON.

### Inactivity WLAN OFF Timer (Default: 20min)

Selects whether or not to automatically turn OFF the WLAN function. When this function is ON, and no device connects to the transceiver, the WLAN function is turned OFF after this set period of time.

- ① This function is disabled when using an external power source, or “Connection Type” is set to “Station (Connect to Network).”
- OFF: Does not turn OFF the WLAN function.
- 5/10/20/30/60min:  
Turns OFF the WLAN function after this set period of time.

### IP Address (Default: 192.168.59.1 (Fixed))

Displays the transceiver’s IP address.

- ① You cannot change the IP address.

## ◇SD Card

The “Save Form” and “Firmware Update (AH-705)” items are added.

**MENU** » **SET > SD Card**

### Save Form (Default: Now Ver)

Selects the format to save the settings to a microSD card.

- Now Ver: Saves the settings in the current version format.
- Old Ver (x.xx - x.xx):  
Saves the settings in an older version format indicated in the parenthesis (x.xx = version).

- ① If you select “Old Ver (x.xx - x.xx),” a function that is added when the transceiver’s firmware format is updated will not be saved.
- ① You cannot load a setting file that is saved in the current version format to an earlier firmware version.

### Firmware Update (AH-705)

Displays the AH-705’s Firmware Update mode.

## Changed Latitude/Longitude unit

“ddd.dddd°” is added to Latitude/Longitude unit setting.

**MENU** » **SET > Display > Display Unit > Latitude/Longitude**

When the Latitude/Longitude unit is set to “ddd.dddd°,” “Alarm Area (Group)” is set to between 0.0014° and 0.9999° (0.0001° steps).

**MENU** » **GPS > GPS Alarm > Alarm Area (Group)**

## Changed Tone Control settings in the Data mode

In the Data mode, the Tone Control settings are automatically disabled.

**MENU** » **SET > Tone Control/TBW > RX**

- RX HPF/LPF (Default: - - - - -)
- RX Bass (Default: 0)
- RX Treble (Default: 0)

## Changed CI-V commands

The following commands are changed in, or added to the conventional Command table.

Cmd.	Sub cmd.	Data	Description	
1A*	05	<b>SET &gt; Display</b>		
		0156	00 ~ 02	Display Unit > Send/read the Latitude/Longitude setting (00=ddd°mm.mm', 01=ddd°mm'ss" 02=ddd.dddd°)
		<b>SET &gt; Time Set</b>		
		0165	20200101 ~ 20991231	Date/Time > Send/read the Date setting (20200101=2020/1/1 ~ 20991231=2099/12/31)
		<b>SCOPE &gt; SCOPE SET</b>		
		0176	00/01	Send/read the Marker Position (FIX Type/SCROLL Type) setting (00=Filter Center, 01=Carrier Point)
		<b>SET &gt; Function &gt; Tuner</b>		
		0365	00/01	Send/read the Tuner Select setting (00=AH-705, 01=Others)
		0366	00/01	AH-705 > Send/read the Tune Memory setting (00=OFF, 01=ON)
		<b>SET &gt; Function &gt; Front Key Customize</b>		
		0367	See p. 9.	Send/read the [VOX/BK-IN] setting
		0368	See p. 9.	Send/read the [AUTOTUNE/RX>CS] setting
		<b>SCOPE &gt; SCOPE SET</b>		
		0369	See p. 9.	FIX Edges > 0.03 - 1.60 > Send/read the No.4 setting
		0370	See p. 9.	FIX Edges > 1.60 - 2.00 > Send/read the No.4 setting
		0371	See p. 9.	FIX Edges > 2.00 - 6.00 > Send/read the No.4 setting
		0372	See p. 9.	FIX Edges > 6.00 - 8.00 > Send/read the No.4 setting
		0373	See p. 9.	FIX Edges > 8.00 - 11.00 > Send/read the No.4 setting
		0374	See p. 9.	FIX Edges > 11.00 - 15.00 > Send/read the No.4 setting
		0375	See p. 9.	FIX Edges > 15.00 - 20.00 > Send/read the No.4 setting
		0376	See p. 9.	FIX Edges > 20.00 - 22.00 > Send/read the No.4 setting
		0377	See p. 9.	FIX Edges > 22.00 - 26.00 > Send/read the No.4 setting
		0378	See p. 9.	FIX Edges > 26.00 - 30.00 > Send/read the No.4 setting
		0379	See p. 9.	FIX Edges > 30.00 - 45.00 > Send/read the No.4 setting
		0380	See p. 9.	FIX Edges > 45.00 - 60.00 > Send/read the No.4 setting
		0381	See p. 9.	FIX Edges > 60.00 - 74.80 > Send/read the No.4 setting
		0382	See p. 9.	FIX Edges > 74.80 - 108.00 > Send/read the No.4 setting
		0383	See p. 9.	FIX Edges > 108.00 - 137.00 > Send/read the No.4 setting
		0384	See p. 9.	FIX Edges > 137.00 - 200.00 > Send/read the No.4 setting
		0385	See p. 9.	FIX Edges > 400.00 - 470.00 > Send/read the No.4 setting

Cmd.	Sub cmd.	Data	Description
27*	00	See p. 10.	Read the Scope waveform data (Only when "Scope ON/OFF status" (Command: 27 10) and "Scope data output" (Command: 27 11) are set to "ON," outputs the waveform data to the controller.)
	14	0000 ~ 0003	Send/read the Scope Center mode, Fixed mode, SCROLL-C mode, or SCROLL-F mode setting (0000=CENTER mode, 0001=FIX mode, 0002=SCROLL-C mode 0003=SCROLL-F mode)
	15	See p. 10.	Send/read the Span setting in the Center mode or SCROLL-C mode Scope
	16	0001 ~ 0004	Send/read the Edge number setting in the Fixed mode or SCROLL-F mode Scope

\*(Asterisk) Send/read data



Changed CI-V commands

◆ Command formats

• Remote MIC Key setting

Command: 1A 05 0074 ~ 1A 05 0077

Data	Function
⋮	⋮
20	Voice/Keyer/RTTY Memory 1
21	Voice/Keyer/RTTY Memory 2
22	Voice/Keyer/RTTY Memory 3
23	Voice/Keyer/RTTY Memory 4
⋮	⋮
30	TUNER

• [VOX/BK-IN] setting

Command: 1A 05 0367

Data	Function
00	TRANSMIT
01	TUNER
02	VOX/BK-IN
03	P.AMP/ATT
04	NOTCH
05	NB
06	NR
07	SPLIT
08	A/B
09	VFO/MEMO
10	CD
11	PRESET
12	Home CH
13	Temporary Skip
14	Voice/Keyer/RTTY Memory 1
15	Voice/Keyer/RTTY Memory 2
16	Voice/Keyer/RTTY Memory 3
17	Voice/Keyer/RTTY Memory 4

• [AUTOTUNE/RX>CS] setting

Command: 1A 05 0368

Data	Function
00	AUTOTUNE/RX>CS
01	CD/RX>CS
02	PRESET/RX>CS
03	Home CH/RX>CS
04	Temporary Skip/RX>CS

• Bandscope edge frequency settings

Command: 1A 05 0188 ~ 1A 05 0238  
1A 05 0369 ~ 1A 05 0385

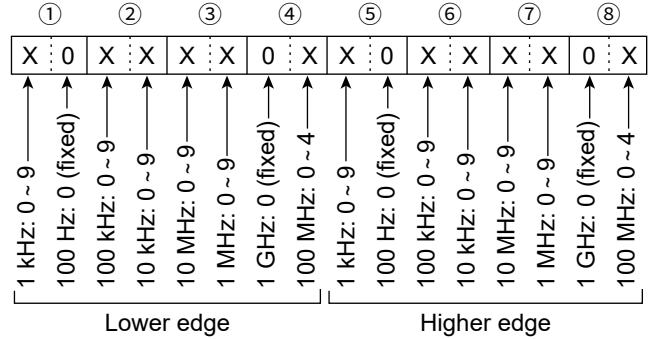

Changed CI-V commands

◇ Command formats

• Scope waveform data

Command: 27 00

Outputs the waveform data to the controller.

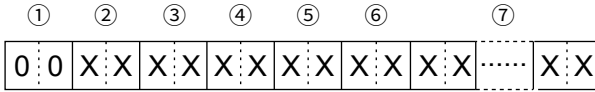

- ①: 00 (Fixed)
- ②: Order of division data (Current): 01~11
- ③: Division number (Maximum): 01(WLAN), 11(USB)
  - ① When data is sent to the controller using the WLAN function, all data is sent together. However, when the data is sent through the [microUSB] port, the data is divided by 11 and sent in sequential order.
  - ② The 1st data sends only the wave information (① ~ ⑥) without the waveform data (⑦). The 2nd or later data sends the minimum wave information (① ~ ③) with waveform data (⑦).

- ④: Spectrum scope mode data:
  - 00 = Center mode scope
  - 01 = Fixed mode scope
  - 02 = SCROLL-C mode scope
  - 03 = SCROLL-F mode scope
- ⑤: Waveform information:
 

The waveform information differs, depending on the Spectrum scope mode.

  - In the Center mode:
 

Center frequency and span are sent. See page 16 of the CI-V Reference Guide for Operating frequency data, and the Scope span settings to the right.
  - In the Fixed, SCROLL-C, and SCROLL-F modes:
 

Lower edge and higher edge frequencies are sent. See page 27 of the CI-V Reference Guide for Scope Fixed edge frequency settings ③ ~ ⑫.

- ⑥: Out of range information:
  - 00 = In range
  - 01 = Out of range
  - ① If the scope data is out of range, the waveform data (⑦) is omitted.

- ⑦: Waveform data:
 

The transceiver outputs the drawn waveform data. The data range or data length of the waveform data is judged by the controller. (The data range is basically the same as the display size of the scope on the controller.)

  - Data range: 0 ~ 160
  - Data length: 475

• Scope span settings

(in the Center mode and SCROLL mode Scope)

Command: 27 15

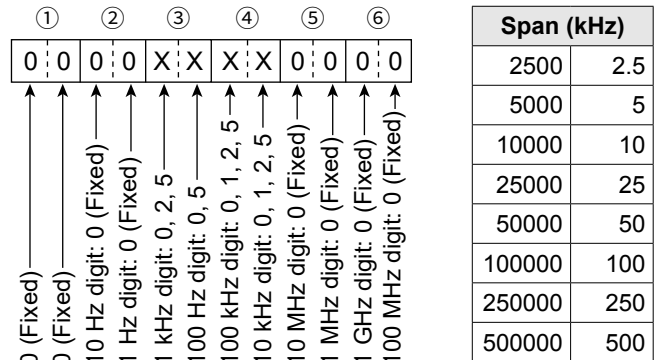

• Scope Fixed edge frequency settings

Command: 27 1E

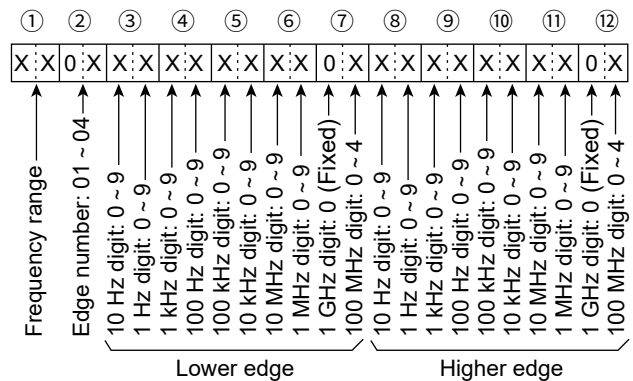

① Entry of less than 1 kHz digits is ignored.

① Selectable Frequency ranges:

Data	Frequency range (Hz)
01	0.03 ~ 1.60
02	1.60 ~ 2.00
03	2.00 ~ 6.00
04	6.00 ~ 8.00
05	8.00 ~ 11.00
06	11.00 ~ 15.00
07	15.00 ~ 20.00
08	20.00 ~ 22.00
09	22.00 ~ 26.00
10	26.00 ~ 30.00
11	30.00 ~ 45.00
12	45.00 ~ 60.00
13	60.00 ~ 74.80
14	74.80 ~ 108.00
15	108.00 ~ 137.00
16	137.00 ~ 200.00
17	400.00 ~ 470.00

② Selectable Edge number: 01=1, 02=2, 03=3, 04=4

# INFORMATION

## IC-705 Version 1.12

The following features are now changed in, or added to, the IC-705.

**Added** : New functions and/or menus have been added.

**Changed** : Some operations, items, and/or options that already exist have been changed.

### Changed **Set mode**

The optional BP-307 is now available.

The following settings are added because the discharge characteristics are different between the BP-307 and the supplied BP-272.

**MENU** » **SET > Function**

#### **Battery Pack Select** (Default: BP-272)

Selects the model of the attached battery pack to display the optimized battery status.

#### **Battery Pack Confirmation** (Default: OFF)

Selects whether or not to display the Battery Pack Select dialog when the first time the transceiver is turned ON after reattaching a battery pack.

### Changed **VOLTAGE** screen

**MENU** » **SET > Others > Information > Voltage**

The [SET] button is added, and the selected battery pack is displayed.

Touching [SET] opens the BATTERY SET screen, and you can set "Battery Pack Select" and "Battery Pack Confirmation."

# INFORMATION

## IC-705 Version 1.11

The following features are now changed in, or added to, the IC-705.





**Added** : New functions and/or menus have been added.

**Changed** : Some operations, items, and/or options that already exist have been changed.

### Changed **Battery icon**

A red battery icon  is added.

Old Version:  →  →  (green) → Blinks

New Version:  →  →  (green) →  (red)

→ Blinks

① Immediately charge the battery pack when the red battery icon is displayed. Otherwise, the icon will soon start blinking, "LOW BATTERY" will be displayed, and the transceiver will automatically turn OFF.