



INSTRUCTION MANUAL

SURVIVAL CRAFT 2-WAY RADIO IC-GM1600

This device complies with Part 15 of the FCC Rules. Operation is subject to the condition that this device does not cause harmful interference.

Icom Inc.



SAFETY TRAINING INFORMATION



Your Icom radio generates RF electromagnetic energy during transmit mode.

This radio has been evaluated for compliance at the distance of 2.5 cm with the FCC RF exposure limits for “Occupational Use Only”. In addition, your Icom radio complies with the following Standards and Guidelines with regard to RF energy and electromagnetic energy levels and evaluation of such levels for exposure to humans:

- FCC OET Bulletin 65 Edition 97-01 Supplement C, Evaluating Compliance with FCC Guidelines for Human Exposure to Radio Frequency Electromagnetic Fields.
- American National Standards Institute (C95.1-1992), IEEE Standard for Safety Levels with Respect to Human Exposure to Radio Frequency Electromagnetic Fields, 3 kHz to 300 GHz.
- American National Standards Institute (C95.3-1992), IEEE Recommended Practice for the Measurement of Potentially Hazardous Electromagnetic Fields— RF and Microwave.
- The following accessories are authorized for use with this product. Use of accessories other than those specified may result in RF exposure levels exceeding the FCC requirements for wireless RF exposure.; Belt Clip (MB-86, MB-103Y), Rechargeable Ni-Cd Battery Pack (BP-224) and Lithium Battery Pack (BP-234).



To ensure that your expose to RF electromagnetic energy is within the FCC allowable limits for occupational use, always adhere to the following guidelines:

- **DO NOT** operate the radio without a proper antenna attached, as this may damage the radio and may exceed FCC RF exposure limits. A proper antenna is the antenna supplied with this radio by the manufacturer or an antenna specifically authorized by the manufacturer for use with this radio.
- **DO NOT** transmit for more than 50% of total radio use time (“50% duty cycle”). Transmitting more than 50% of the time can cause FCC RF exposure compliance requirements to be exceeded. The radio is transmitting when the “TX indicator” light is red. You can cause the radio to transmit by pressing the “PTT” switch or VOX function.
- **ALWAYS keep** the antenna at least 2.5 cm (1 inch) away from the body when transmitting and only use the Icom belt-clips which are listed on page 26 when attaching the radio to your belt, etc., to ensure FCC RF exposure compliance requirements are not exceeded. To provide the recipients of your transmission the best sound quality, hold the radio in an almost vertical position at least 5 cm (2 inches) from your mouth, the microphone is located next to the speaker, so you should “talk into the speaker”.

The information listed above provides the user with the information needed to make him or her aware of RF exposure, and what to do to assure that this radio operates within FCC RF exposure limits.

Electromagnetic Interference/Compatibility

During transmissions, your Icom radio generates RF energy that can possibly cause interference with other devices or systems. To avoid such interference, turn off the radio in areas where signs are posted to do so. **DO NOT** operate the transmitter in areas that are sensitive to electromagnetic radiation such as hospitals, aircraft, and blasting sites.

RECOMMENDATION

CLEAN THE TRANSCEIVER THOROUGHLY WITH FRESH WATER after exposure to saltwater, and dry it before operation. Otherwise, the transceiver's keys, switches and controllers may become inoperable due to salt crystallization.

NOTE: DO NOT wash the transceiver in water if there is any reason to suspect the waterproofing may not be effective. For example, in cases where the battery pack rubber seal is damaged, the transceiver/battery pack is cracked or broken, or has been dropped, or when the battery pack is detached from the transceiver.

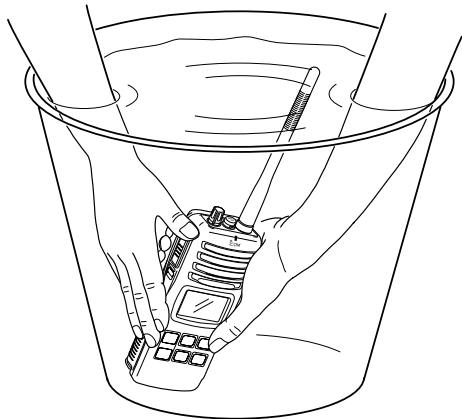

FOREWORD

Thank you for purchasing this Icom radio. The IC-GM1600 SURVIVAL CRAFT 2-WAY RADIO is designed and built with Icom's state of the art technology and craftsmanship. With proper care, this product should provide you with years of trouble-free operation.

IMPORTANT

READ ALL INSTRUCTIONS carefully and completely before using the transceiver.

SAVE THIS INSTRUCTION MANUAL—This instruction manual contains important operating instructions for the IC-GM1600.

EXPLICIT DEFINITIONS

WORD	DEFINITION
⚠ WARNING	Personal injury, fire hazard or electric shock may occur.
CAUTION	Equipment damage may occur.
NOTE	If disregarded, inconvenience only. No risk of personal injury, fire or electric shock.

PRECAUTION

⚠ WARNING! NEVER connect the transceiver to an AC outlet. This may pose a fire hazard or result in an electric shock.

⚠ WARNING! NEVER hold the transceiver so that the antenna is closer than 2.5 cm (1 inch) from exposed parts of the body, especially the face or eyes, while transmitting. The transceiver will perform best if the microphone is 5 to 10 cm (2 to 4 inches) away from the lips and the transceiver is vertical.

NEVER connect the transceiver to a power source other than the BP-224 or BP-234. Such a connection will ruin the transceiver.

AVOID using or placing the transceiver in direct sunlight or in areas with temperatures below -20°C (-4°F) or above $+60^{\circ}\text{C}$ ($+140^{\circ}\text{F}$) for U.S.A. version; -20°C (-4°F) or above $+55^{\circ}\text{C}$ ($+131^{\circ}\text{F}$) for General version

KEEP the transceiver out of the reach of children.

KEEP the transceiver at least 0.9 meters (3.0 ft) away from your vessel's magnetic navigation compass.

MAKE SURE the flexible antenna and battery pack are securely attached to the transceiver, and that the antenna and battery pack are dry before attachment. Exposing the inside of the transceiver to water will result in serious damage to the transceiver.

For U.S.A. only

CAUTION: Changes or modifications to this device, not expressly approved by Icom Inc., could void your authority to operate this device under FCC regulations.

Icom, Icom Inc. and the ICOM logo are registered trademarks of Icom Incorporated (Japan) in the United States, the United Kingdom, Germany, France, Spain, Russia and/or other countries.

TABLE OF CONTENTS

SAFETY TRAINING INFORMATION	i	5 SET MODE	11–15
RECOMMENDATION	ii	■ SET mode programming	11
FOREWORD	ii	■ SET mode items	12
IMPORTANT	ii	6 BP-234 BATTERY PACK	16
EXPLICIT DEFINITIONS	ii	7 BATTERY CHARGING (FOR ON-BOARD USE ONLY)	17–20
PRECAUTION	iii	■ Battery charging	17
TABLE OF CONTENTS	iv	■ Battery cautions	17
1 OPERATING RULES	1	■ Optional battery chargers	19
2 SUPPLIED ACCESSORIES AND ATTACHMENTS	2–3	8 OPTIONAL SWIVEL BELT CLIP	21
■ Supplied accessories	2	■ MB-86 contents	21
■ Attachments	2	■ Attachment	21
3 PANEL DESCRIPTION	4–6	■ Detachment	21
■ Front, top and side panels	4	9 OPTIONAL SPEAKER-MICROPHONE	
■ Function display	5	(FOR ON-BOARD USE ONLY)	22
4 BASIC OPERATION	7–10	■ HM-125 descriptions	22
■ Channel selection	7	■ Attachment	22
■ Receiving and transmitting	8	10 CHANNEL LIST FOR SURVIVAL OPERATION	23
■ Call channel programming	9	11 TROUBLESHOOTING	24
■ Adjusting the squelch level	9	12 SPECIFICATIONS	25
■ Lock function	10	13 OPTIONS	26
■ Signal strength indicator function	10		
■ Monitor function	10		
■ Backlighting function	10		
■ VOX function (FOR ON-BOARD USE ONLY)	10		



◇ Priorities

- Read all rules and regulations pertaining to priorities and keep an up-to-date copy handy. Safety and distress calls take priority over all others.
- You must monitor Channel 16 when you are not operating on another channel.
- False or fraudulent distress calls are prohibited under law.

◇ Privacy

- Information overheard but not intended for you cannot lawfully be used in any way.
- Indecent or profane language is prohibited.

◇ Radio licenses

(1) SHIP STATION LICENSE

When your craft is equipped with a VHF FM transceiver, you must have a current radio station license before using the transceiver. It is unlawful to operate a ship station which is not licensed.

Inquire through your dealer or the appropriate government agency for a Ship-Radiotelephone license. This license includes the call sign which is your craft's identification for radio purposes.

(2) OPERATOR'S LICENSE

A restricted Radiotelephone Operator Permit is the license most often held by small vessel radio operators when a radio is not required for safety purposes.

The Restricted Radiotelephone Operator Permit must be posted near the transceiver or be kept with the operator. Only a licensed radio operator may operate a transceiver.

However, non-licensed individuals may talk over a transceiver if a licensed operator starts, supervises, ends the call and makes the necessary log entries.

A current copy of the applicable government rules and regulations is only required to be on hand for vessels in which a radio telephone is compulsory. However, even if you are not required to have these on hand it is your responsibility to be thoroughly acquainted with all pertinent rules and regulations.

■ Supplied accessories

The following accessories are supplied:	Qty.
① Handstrap	1
② Battery charger (BC-158)	1
③ Belt clip (MB-103Y)	1
④ AC adapter (BC-147A/E)*	1
⑤ Ni-Cd battery pack (BP-224)	1

*Depends on versions.

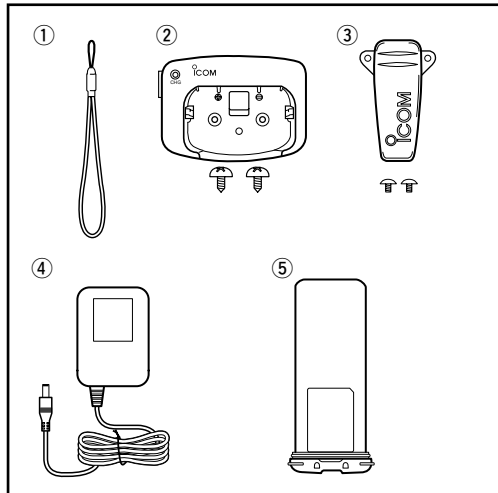

■ Attachments

◇ Handstrap

Pass the handstrap through the loop on the top of the transceiver as illustrated at right. Facilitates carrying.

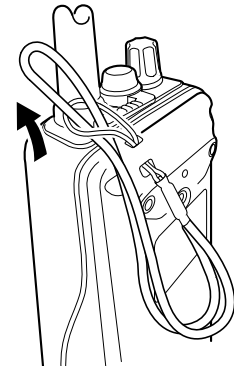

◇ Belt clip

Attach the belt clip to the transceiver as illustrated below.

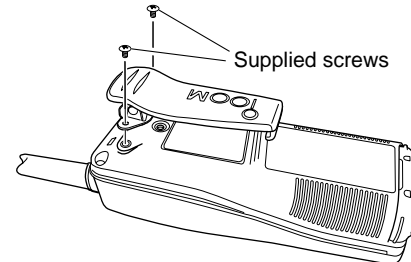

2 SUPPLIED ACCESSORIES AND ATTACHMENTS

◆ Battery pack

To remove the battery pack:

Turn the screw counterclockwise, then pull the battery pack in the direction of the arrow as shown below.

To attach the battery pack:

Insert the battery pack in the IC-GM1600 completely, then turn the screw clockwise.

NEVER remove or insert the battery pack when the transceiver is wet or soiled. This may result water or dust getting into the transceiver/battery pack and may result in the transceiver being damaged.

NOTE: When the lock screw does not easily turn (feels tight), check to ensure the battery pack is sufficiently inserted to the transceiver. **DO NOT** bang or cause high impact to the battery pack, as this may damage the battery pack/or the transceiver.

Screw position
when removing battery

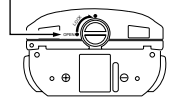

Screw position
when attaching battery

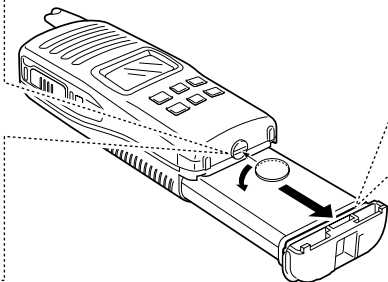
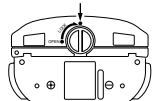

NOTE: When removing or attaching the battery pack, use a coin or flat-blade screwdriver to loosen or tighten the bottom screw.

CAUTION!: When attaching or removing a battery pack, make sure the rubber seal is set in the groove of the battery pack correctly. If the seal is not neatly in the groove it may be damaged when attaching the battery pack. If the seal is damaged, waterproofing is not guaranteed.

NOTE: When attaching a battery pack, make sure dust or else does not adhere to the rubber seal. If dust or anything else is on the seal when attaching a battery pack, the water resistant seal may be compromised.

Make sure both the rubber seal (purple) is set into the groove correctly and dust or else does not adhere to it.

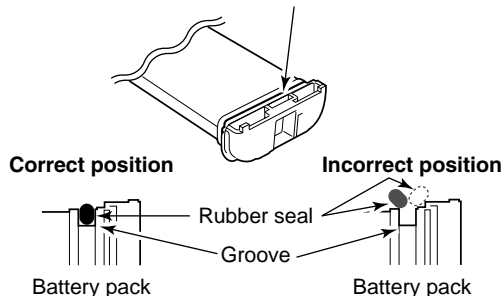

■ Front, top and side panels

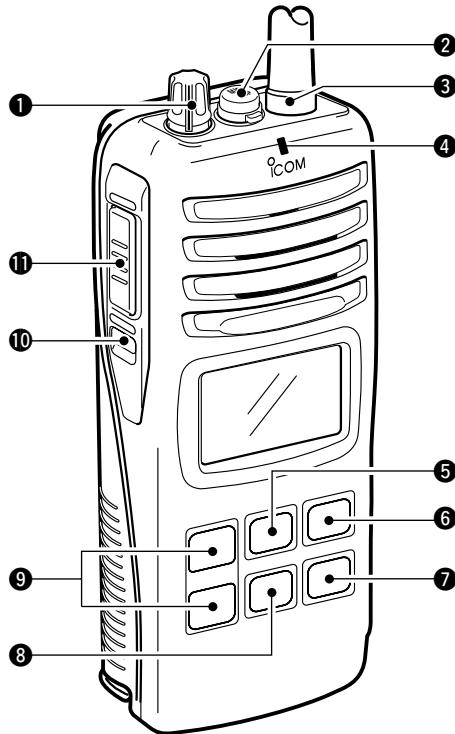

① VOLUME CONTROL [VOL]

Turns power ON and adjusts the audio level.

② MICROPHONE CONNECTOR [MIC/SP]

Connects the optional external microphone.

/// **NOTE:** Attach the [MIC/SP] cap when the optional speaker-microphone is not used.

③ ANTENNA

Fixed type.

④ TRANSMIT/RECEIVE INDICATOR

Lights green while receiving a signal or when the squelch is open; lights red while transmitting (lights orange while VOX function is used).

⑤ CALL CHANNEL KEY [CALL]

➤ Selects the call channel when pushed. (p. 7)

- Channel 9* is factory default.

*Channel 16 is set as factory default by version.

➤ Push for 3 sec. to enter call channel programming condition. (p. 9)

⑥ CHANNEL KEY [CH]

Push to return the previous condition when distress channel or call channel is selected. (p. 7)

⑦ TRANSMIT POWER/LOCK KEY [Hi/Lo••]

➤ Selects high or low power when pushed. (p. 8)

➤ Toggles the lock function ON/OFF when pushed for 1 sec. (p. 10)

3 PANEL DESCRIPTION

8 CHANNEL 16 KEY [16]

Selects Channel 16 when pushed. (p. 7)

9 CHANNEL UP/DOWN KEYS [▲]/[▼]

- ➔ Selects an operating channel. (pgs. 7–8)
- ➔ Selects the SET mode condition of the item. (p. 11)
- ➔ Selects the SET mode item when pushed with [SQL]. (p. 11)

10 SQUELCH SWITCH [SQL•MONI]

- ➔ Push this switch, then adjust the squelch level with [▲]/[▼]. (p. 9)
- ➔ Manually opens the squelch for monitoring the channel while pushed and held. (p. 10)
- ➔ While pushing this switch, turn power ON to enter the SET mode. (p. 11)

11 PTT SWITCH [PTT]

Push and hold to transmit; release to receive.

■ Function display

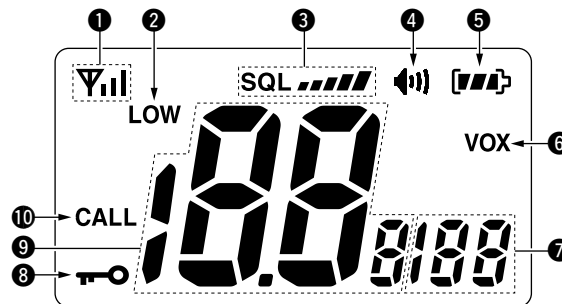

- 1 SIGNAL STRENGTH INDICATOR** (pgs. 10, 14)
Shows the relative signal strength while receiving signals.
- 2 TRANSMIT POWER INDICATOR** (p. 8)
 - ➔ “LOW” appears when low power is selected.
 - ➔ No indication appears when high power is selected.
- 3 SQUELCH LEVEL INDICATOR** (p. 9)
Shows the squelch level.
- 4 MONITOR INDICATOR** (p. 10)
Appears when the monitor function is activated.

5 BATTERY INDICATOR

Indicates remaining battery power.

• **Using rechargeable battery pack**

Indication					
Battery level	Full	Middle	Charging required		No battery

blinks when the battery is over charged.

• **Using BP-234 battery pack**

Indication					
Battery level	Full	Middle	A new battery pack is required		No battery

6 VOX INDICATOR

“VOX” appears when the VOX function is used. (p. 10)

7 SET MODE ITEM READOUT

Indicates the SET mode items while in the SET mode. (p. 11)

8 LOCK INDICATOR

Appears when the lock function is activated. (p. 10)

9 CHANNEL NUMBER READOUT

- Indicates the selected operating channel number.
- In SET mode, indicates the selected condition.

10 CALL CHANNEL INDICATOR

Appears when the call channel is selected. (p. 7)

■ Channel selection

◇ Channel 16

Channel 16 (Distress channel) is used for establishing initial contact with another station and for emergency communications. While standing by, you must monitor Channel 16.

- ① Push [16] to select Channel 16.
- ② Push [CH] to return to the condition before selecting Channel 16, or push [▲]/[▼] to select the operating channel.

Push

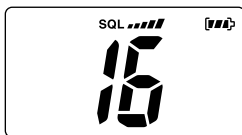

Push

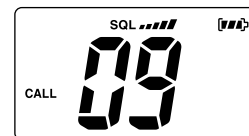

◇ Call channel

The call channels can be re-programmed (p. 9) and may be used to store your most often used channels for quick recall.

- ① Push [CALL] to select the call channel.
 - “CALL” and the call channel number appear.
 - Call channel can be re-programmed. See the “Call channel programming” on p. 9 for details.
- ② Push [CH] to return to the condition before selecting the call channel, or push [▲]/[▼] to select the operating channel.

■ Receiving and transmitting

- ① Rotate [VOL] clockwise to turn power ON.
- ② Set the volume and squelch level.
 - ➔ Push [SQL•MONI], and push [▼] to open the squelch.
 - ➔ Push [SQL•MONI] to stop the “SQL” indicator blinking, then rotate [VOL] to set the volume level.
 - ➔ Push [SQL•MONI], and push [▲]/[▼] to set the squelch level.
- ③ Push [▲]/[▼] to select the desired channel.
 - When receiving a signal, the [TRANSMIT/RECEIVE] indicator lights green while audio is emitted from the speaker.
 - Further adjustment of [VOL] may be necessary at this point.
- ④ Push [Hi/Lo•] to select the output power if necessary.
 - “LOW” appears when low power is selected; no indication when high power is selected.
 - Choose low power to conserve battery power, choose high power for longer distance communications.
 - Some channels are for low power only.
- ⑤ Push and hold [PTT] to transmit, then speak into the microphone.
 - The [TRANSMIT/RECEIVE] indicator lights red while transmitting.
- ⑥ Release [PTT] to receive.

IMPORTANT: To maximize the readability of your transmitted signal, pause a moment after pushing [PTT], hold the microphone 5 to 10 cm (2 to 4 inches) from your mouth and speak into the microphone at a normal voice level.

NOTE: The transceiver has a power save function to conserve the battery power. The power save function activates automatically when no signal is received for 5 sec.

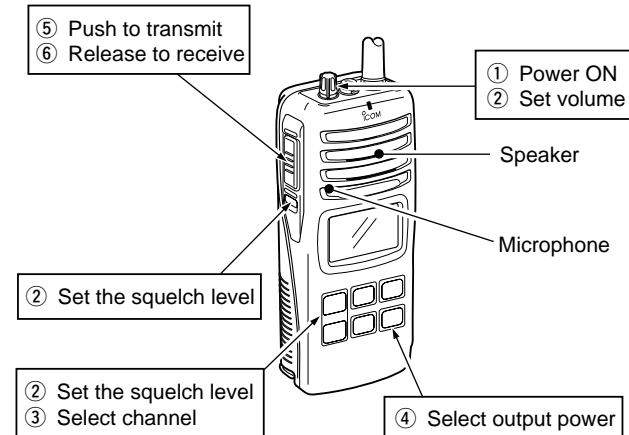

4 BASIC OPERATION

■ Call channel programming

The call channel switch is used to select Channel 9* by default, however, you can program your most often-used channel for quick recall.

*The channel number depends on version.

- ① Push [CALL] to select the call channel.

- “CALL” and call channel number appear.



- ② Push [CALL] again for 3 sec. (until a long beep changes to 2 short beeps) to enter call channel programming condition.

- Call channel number to be programmed flashes.



- ③ Push [▲]/[▼] to select the desired channel.

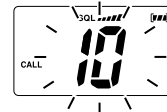

- ④ Push [CALL] to program the displayed channel as the call channel.

- The call channel number stops flashing.

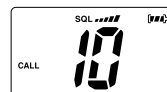

■ Adjusting the squelch level

To adjust the IC-GM1600's squelch level, use the [▲]/[▼] keys. In order to receive signals properly, the squelch must be adjusted to the proper level.

- ① Push [SQL•MONI], then adjust the squelch level with [▲]/[▼].
 - “SQL” indicator starts blinking.
 - There are 11 squelch levels to choose from: OP is completely open; 10 is tight squelch; 1 is loose squelch level.
- ② Push [SQL•MONI] again to return to normal condition.
 - When no switch is pushed for 5 sec., the transceiver returns to normal condition.

Blinks during the squelch level adjustment.

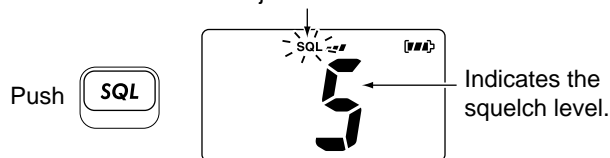

■ Lock function

This function electronically locks all keys (except for [PTT], [SQL•MONI] and [Hi/Lo•

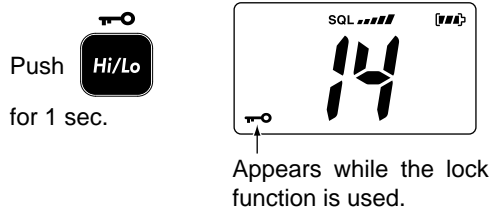

➔ Push [Hi/Lo•



■ Signal strength indicator

The received signal strength level is indicated by number of bars as below.

- Only the antenna mark appears when receiving no signal or a very weak signal when the signal strength indicator is set to ON in the SET mode (p. 14).
- This indicator can be hidden by using the SET mode (p. 14) if desired.

Indication				
Signal strength	Strong	Middle	Weak	No signal or Very weak

■ Monitor function

The monitor function releases the noise squelch mute to check the volume level. See p. 12 for details of the monitor switch action.

- ➔ Push [SQL•MONI] for 1 sec. and keep holding to activate the monitor function.
 - “

■ Backlighting function

This function is convenient for nighttime operation. The backlighting brightness can be adjusted in the SET mode. (p. 12)

- ➔ Push any key except for [PTT] to turn the backlighting ON.
 - “

■ VOX function (FOR ON-BOARD USE ONLY)

The VOX function (voice operated transmission) starts transmission without pushing [PTT] when you speak into the microphone; then automatically returns to receive when you stop speaking (hands-free operation becomes possible).

NOTE: An optional headset and headset adapter (OPC-1392) is required for the VOX operation.

- ➔ Push and hold [SQL•MONI], then push [Hi/Lo•- “VOX” appears on the LCD while the VOX function is ON.
- The “VOX gain” and “VOX delay” can be set in the SET mode. (pgs. 14 and 15)

■ SET mode programming

SET mode is used to change the condition of 11 transceiver functions: beep tone function, monitor switch action, back-lighting function, LCD contrast selection, auto power save function, self check function, battery voltage indicator, signal strength indicator, squelch sensitivity function, VOX gain* and VOX delay*.

*Available for on-board use only.

◇ SET mode operation

- ① Turn power OFF.
- ② While pushing [SQL•MONI], turn power ON to enter the SET mode.
 - “bp” (Beep tone function setting) appears.
- ③ Push [SQL•MONI] or [SQL•MONI] and [▲]/[▼] to select the desired item, if necessary.
- ④ Push [▲]/[▼] to select the desired condition of the item.
- ⑤ Push [16] to exit the SET mode.

◇ SET MODE ITEMS The displays show the default settings, and the selected item is displayed in the dotted circle.

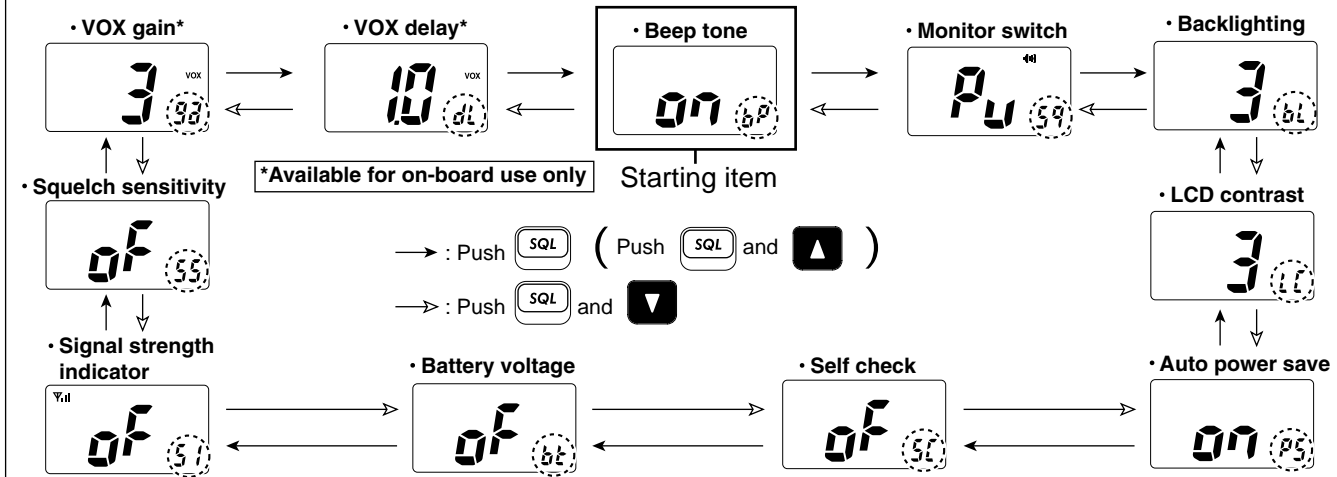

■ SET mode items

◇ Beep tone function “bP”

You can select silent operation by turning the beep tones OFF, or you can have 2 types of confirmation beeps sound at the push of a key. When “ON” is selected, a fixed beep (Pi) sounds, and when “US” is selected, the preset beeps (e.g. do, re, mi) sound.

- Beep tone synchronizes with the volume level.
- The beeps sound during call channel programming even if this function is turned OFF.



Beep tone ON (default)



Beep tone OFF

◇ Monitor switch action “Sq”

The monitor switch action cuts off the squelch function temporarily. This switch action contains PUSH (Pu) or HOLD (Ho) settings as shown below.

- PU (PUSH): After pushing [SQL•MONI] for 1 sec., the squelch opens and emits audio. The squelch is held open while continuously pushing and holding [SQL•MONI]. (default)
- HO (HOLD): After pushing [SQL•MONI] for 1 sec., the squelch opens and emits audio even if [SQL•MONI] is released. To close the squelch, push any switch.



PUSH setting (default)



HOLD setting

◇ Backlighting function “bL”

This function is convenient for nighttime operation. The backlighting brightness can be adjusted from OFF, 1 (dark)—3 (bright); 3 (default). Select 1–3 to turn this function ON.

- The automatic backlighting turns the backlighting ON when any switch except for [PTT] is pushed.
- The backlighting is automatically turned OFF after 5 sec. of inactivity.



Backlighting ON
(default)



Backlighting OFF

◇ LCD contrast selection “LC”

The contrast of the LCD can be adjusted from 4 levels.

- 1 (bright)—4 (dark); 3 (default)

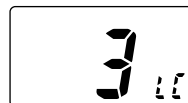

Middle contrast
(default)

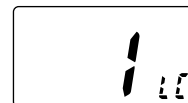

Low contrast

5 SET MODE

◇ Auto power save function “PS”

The auto power save function reduces battery drain by deactivating the receiver circuit for preset intervals.

- ON : The power save function is turned ON. The power save function will activate when no signal is received, and no operation is performed for 5 sec.
- OFF: The power save function is turned OFF.

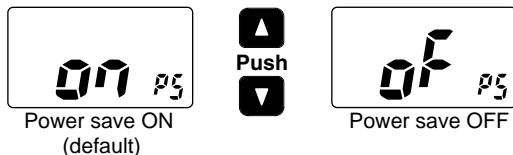

◇ Self check function “SC”

The self check function checks the transceiver conditions by itself, and informs you in case a problem is found. Self check automatically and quickly runs through its diagnostic steps each time the radio is turned ON. Afterwards, the radio switches to normal operation mode.

- Temperature : Outside of -35°C to $+80^{\circ}\text{C}$; -31°F to $+173^{\circ}\text{F}$ (approx.)
- Connected battery voltage

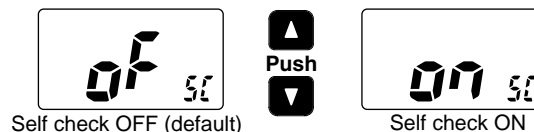

When error messages as shown below are displayed, see troubleshooting for advice. (p. 24)

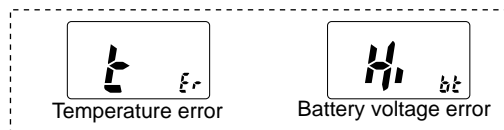

◇ Battery voltage indicator “bt”

This function controls display or non-display settings of the connected battery pack’s voltage when the power is ON.

- The voltage of the connected battery pack is displayed for 2 sec. after power is turned ON.

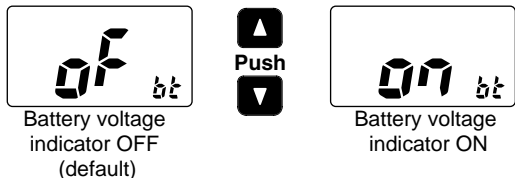

◇ Signal strength indicator “SI”

The signal strength indicator displays received signal strength like an “S-meter”. This function is convenient to check the signal strength visually.

- The strength is displayed at 4 steps.
- The antenna mark and 3 bars appear when receiving strong signals.
- The antenna mark only appears when receiving no signal when the signal strength indicator is ON.

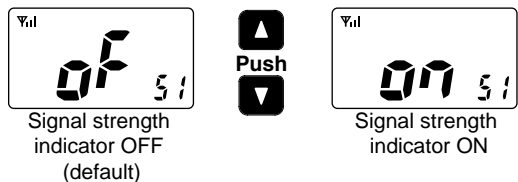

◇ Squelch sensitivity function “SS”

When this function is turned ON, blocking against noise is improved. Therefore the squelch is not easily affected by noise.

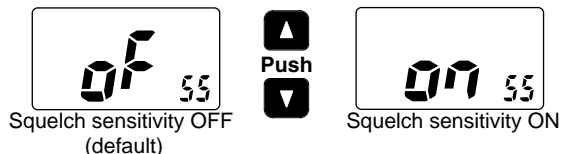

◇ VOX gain “ga” (Available for on-board use only)

Adjusts the VOX gain level (from 1 to 6) when speaking into the optional headset.

- Setting the VOX gain to 1 increases the sensitivity.
- Setting the VOX gain to 6 reduces the sensitivity.

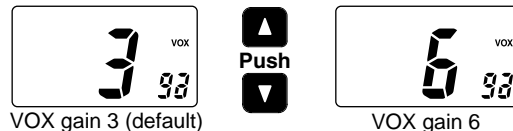

5 SET MODE

◇ VOX delay “dL” (Available for on-board use only)

Sets the VOX delay timer (0.5 to 3.0 sec. in 0.5 sec. steps) keeping the radio in transmit mode after you stop speaking.

- Setting the delay to 0.5 (0.5 sec.) is a short VOX delay.
- Setting the delay to 3.0 (3.0 sec.) is a long VOX delay.

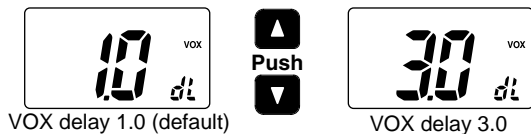

SET MODE LIST

Function	Indication	Condition
Beep tone function	“bP”	OFF/ON*/US
Monitor switch action	“Sq”	PUSH*/HOLD
Backlighting function	“bL”	OFF/1/2/3*
LCD contrast selection	“LC”	1/2/3*/4
Auto power save function	“PS”	OFF/ON*
Self check function	“SC”	OFF*/ON
Battery voltage indicator	“bt”	OFF*/ON
Signal strength indicator	“SI”	OFF*/ON
Squelch sensitivity	“SS”	OFF*/ON
VOX gain	“ga”	1/2/3*/4/5/6
VOX delay	“dL”	0.5/1.0*/1.5/2.0/2.5/3.0

*default setting

The optional BP-234 battery pack is a non-rechargeable, Lithium battery pack for operation in a survival craft. The following precaution must be observed.

- **NEVER** dispose of the BP-234 battery pack in a fire. This could result in an explosion.
- **DO NOT** short-circuit the BP-234 battery pack. Metal contact (such as paper clip, another battery, etc.) across the battery contacts can result in a sustained high rate discharge, which could damage the battery, void the warranty and create a burn or a fire hazard.
- **NEVER** expose of the BP-234 battery pack to excessive heat of 60°C (+140°F) or above. This could result in electrolyte leakage, possibly causing an explosion or fire.
- **NEVER** attempt to recharge the BP-234. Lithium batteries may explode or cause a fire in such cases.
- **DO NOT** disassemble the BP-234 battery pack. The BP-234 battery pack contains no user serviceable parts. Internal battery gas can cause throat irritation. Also, exposed lithium may generate heat and ignite.

- **DO NOT** apply excessive pressure to the battery. This may result in electrolyte leakage, possibly causing an explosion.
- The storage life of the BP-234 is about 5 years. Once the expiration date on the battery pack passes, a new battery pack **must** be purchased.
- For safety reasons, once the BP-234 is used, a spare one should be purchased. The original battery pack can be continued to be used for regular communications; save the spare one for emergency situations.

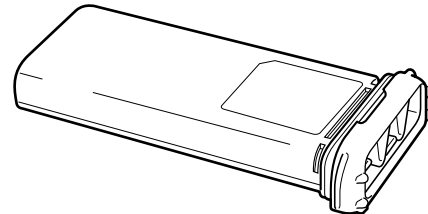

• BP-234 Lithium battery pack

IMPORTANT!

- This battery pack is for **EMERGENCY USE ONLY**.
- Usable temperature range is within -20°C to $+55^{\circ}\text{C}$ (-4°F to $+131^{\circ}\text{F}$).
- Stored temperature range is within -30°C to $+35^{\circ}\text{C}$ (-22°F to $+95^{\circ}\text{F}$).
- Once this bag's seal is broken, a new emergency battery pack must be used for EMERGENCY use.

■ Battery charging

Prior to using the transceiver for the first time, the battery pack must be fully charged for optimum life and operation.

/// **CAUTION:** To avoid damage to the transceiver, turn the power OFF while charging.

- Recommended temperature range for charging: +10°C to +40°C (+50°F to +104°F)
- Use the specified chargers (BC-158, BC-119N and BC-121N). **NEVER** use another manufacturer's charger.
- Use the supplied AC adapter for the BC-158. **NEVER** use another manufacturer's adapters.

◇ Recycling information



The product that you have purchased contains a rechargeable battery. The battery is recyclable. At the end of its life, under various state and local laws, it may be illegal to dispose of this battery into the municipal waste stream. Call 1-800-822-8837 for battery recycling options in your area or contact your dealer.

Turn the transceiver OFF when charging an attached battery pack. Otherwise, the battery pack may not become fully-charging or may not charge properly.

■ Battery cautions

CAUTION! NEVER insert a battery pack or a transceiver (with the battery pack attached) that is wet or soiled into the charger. This may result in corrosion of the charger terminals or damage to the charger. The charger is not waterproof and water can easily get into it.

NEVER incinerate used battery packs. Internal battery gas may cause an explosion.

NEVER immerse a battery pack in water. If the battery pack becomes wet, be sure to wipe it dry immediately (particularly the battery terminals), and especially BEFORE attaching it to the transceiver.

NEVER short terminals of the battery pack. Also, current may flow into nearby metal objects, such as a necklace, etc. Those may cause burn, electric shock or fire. Therefore, be careful when carrying in a pocket, backpack or handbag, and when placing the radio near metal objects.

If your battery pack seems to have no capacity even after being charged, completely discharge it by leaving the power ON overnight. Then, fully charge the battery pack again. If the battery still do not retain a charge (or very little), a new battery pack must be replaced.

◆ Charging connections

- ① Attach the BC-158 to a flat surface, such as a desk.
- ② Connect the AC adapter as shown below.
- ③ Insert the battery pack with/without the transceiver into the charger.
 - The charge indicator lights green.
- ④ Charge the battery pack approx. 8 hours, depending on the remaining power condition.

/// **DO NOT** charge the BP-224 more than 12 hours. Otherwise, the BP-224 will be damaged.

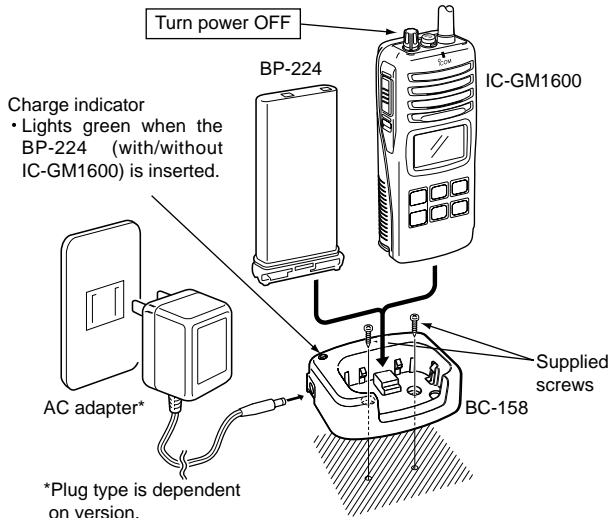

7 BATTERY CHARGING (FOR ON-BOARD USE ONLY)

■ Optional battery chargers

◆ AD-109 installation

- ① Connect the charger's 10-pin connector to the AD-109 desktop charger adapter's plug.

/// **NOTE:** The 3-pin connector is not used.

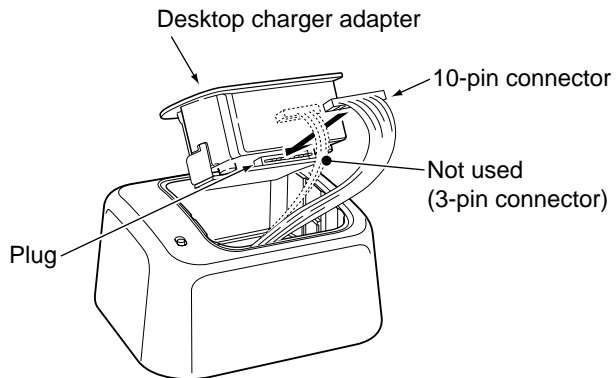

- ② Install the adapter into the charger in the direction of the arrow, then use the supplied 2 screws to attach the charger adapter to the charger.

/// **NOTE: BE CAREFUL** not to catch the unused 3-pin plug between the charger and the charger adapter.

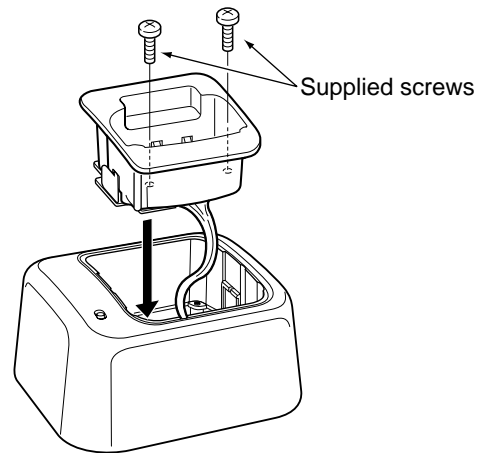

◇ **Rapid charging with the BC-119N+AD-109**

The optional BC-119N provides rapid charging of battery packs. The following are additionally required.

- AD-109 charger adapter
- An AC adapter (BC-145A/E)*¹ or the DC power cable (OPC-515L/CP-17L).

*¹Depends on version.

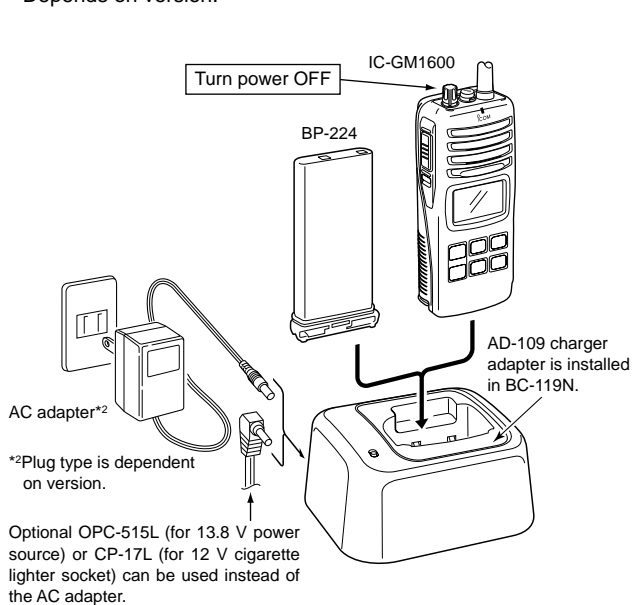

◇ **Rapid charging with the BC-121N+AD-109**

The optional BC-121N allows up to 6 battery packs to be charged simultaneously. The following are additionally required.

- Six AD-109 charger adapters
- An AC adapter (BC-124) or the DC power cable (OPC-656)

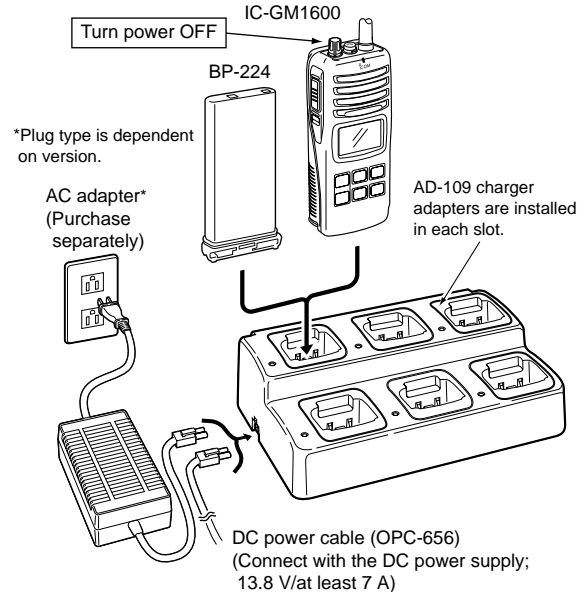

■ MB-86 contents

	Qty.
Belt clip	1
Base clip	1
Supplied screws	2

■ Attachment

- ① Screw the base clip to the back of the transceiver using the two screws (supplied) as shown below.

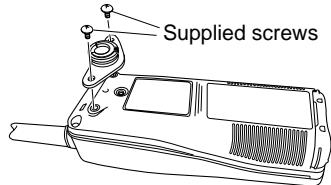

- ② Clip the belt clip over your belt and insert the transceiver.

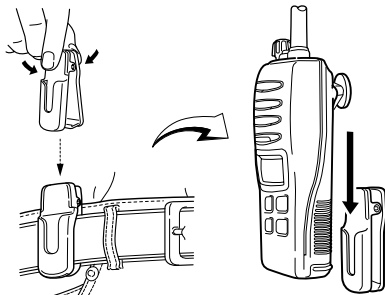

- ③ Once the transceiver is locked in place, it swivels as illustrated below.

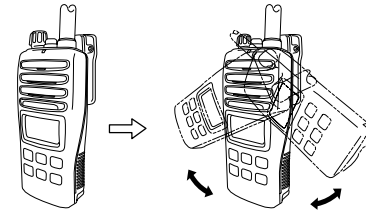

■ Detachment

- ➔ Turn the transceiver upside down in the direction of the arrow and pull out from the belt clip.

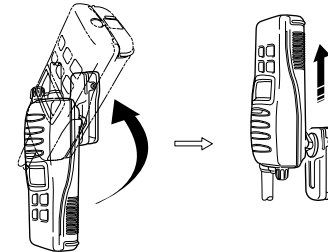

⚠ CAUTION!
HOLD THE TRANSCIVER TIGHTLY, WHEN HANGING OR DETACHING THE TRANSCIVER FROM THE BELT CLIP.
 Otherwise the transceiver may not be attached to the belt clip or swivelled properly attached to the belt clip and may not swivel properly. The transceiver could then be accidentally dropped and scratched or damaged.

■ HM-125 descriptions

Alligator-type clip

To attach the speaker-mic. to your shirt or collar, etc.

PTT switch

Transmits when push.
Receives when release.

Microphone

Speaker

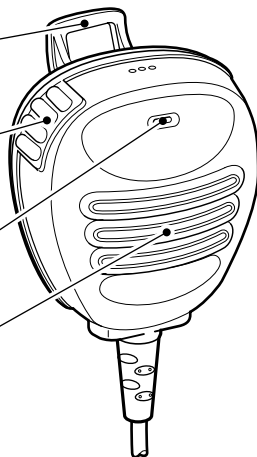

NEVER immerse the connector in water without connecting with the transceiver. If the connector becomes wet, be sure to dry **BEFORE** connecting it to the transceiver.

NOTE: The microphone is located at the top of the speaker-microphone, as shown in the diagram above. To maximize the readability of your transmitted signal (voice), hold the microphone approx. 2.5 cm (1 inch) from your mouth, and speak in a normal voice level.

■ Attachment

Insert the speaker-mic connector onto [MIC/SP] connector and carefully screw it tight, as shown in the diagram below. Be careful not to cross thread the connection.

Set the triangle mark to the front side.

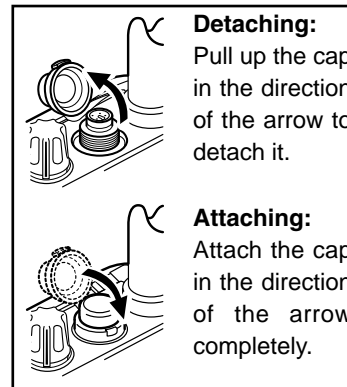
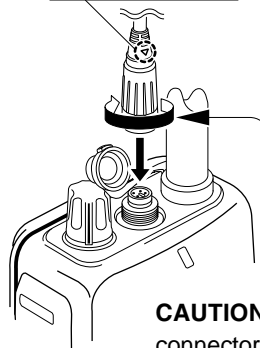

Detaching:

Pull up the cap in the direction of the arrow to detach it.

Attaching:

Attach the cap in the direction of the arrow completely.



CAUTION: Attach the speaker-microphone's connector securely to prevent accidental dropping, or water intrusion into the connector.

IMPORTANT: KEEP the transceiver's [MIC/SP] connector cap attached when the speaker-microphone is not in use. Water will not get into the transceiver even if the cover is not attached, however, the terminals (pins) will become rusty, or the transceiver will function abnormally if the connector has become wet.

10 CHANNEL LIST FOR SURVIVAL OPERATION

Channel number	TX/RX	Channel number	TX/RX	Channel number	TX/RX
06	156.300 MHz	08	156.400 MHz	09	156.450 MHz
10	156.500 MHz	11	156.550 MHz	12	156.600 MHz
13	156.650 MHz	14	156.700 MHz	15*	156.750 MHz
16	156.800 MHz	17*	156.850 MHz	67	156.375 MHz
68	156.425 MHz	69	156.475 MHz	71	156.575 MHz
72	156.625 MHz	73	156.675 MHz	74	156.725 MHz
77	156.875 MHz				

*U.S.A. version is low power only

PROBLEM	POSSIBLE CAUSE	SOLUTION	REF.
The transceiver does not turn ON.	<ul style="list-style-type: none"> The battery is exhausted. Bad connection to the battery pack. 	<ul style="list-style-type: none"> Change to a new battery pack (Survival). Recharge the battery pack (On-board). Check the connection to the transceiver. 	<p>p. 16 pgs. 17–20 p. 3</p>
No sound from the speaker.	<ul style="list-style-type: none"> Squelch level is too deep. Volume level is too low. Speaker has been exposed to water. Water has entered the [MIC/SP] connector. 	<ul style="list-style-type: none"> Set squelch to the threshold point. Rotate [VOL] to set a suitable level. Drain water from the speaker. Dry [MIC/SP] connector. 	<p>p. 9 p. 8 — —</p>
Transmitting is impossible, or high power can not be selected.	<ul style="list-style-type: none"> Some channels are for low power or receive only. The battery is exhausted. The output power is set to low. 	<ul style="list-style-type: none"> Change channels. Change to a new battery pack (Survival). Recharge the battery pack (On-board). Push [Hi/Lo•] to select high power. 	<p>pgs. 8, 23 p. 16 pgs. 17–20 p. 8</p>
The displayed channel cannot be changed.	<ul style="list-style-type: none"> Lock function is activated. 	<ul style="list-style-type: none"> Push [Hi/Lo•] for 1 sec. to cancel the function. 	p. 10
No beeps.	<ul style="list-style-type: none"> Beep tones are turned OFF. 	<ul style="list-style-type: none"> Set the beep tones to ON (Fix Beep/User Beep) on the SET mode. 	p. 12
Self check error. (Temperature)	<ul style="list-style-type: none"> The temperature is outside of -35°C to $+80^{\circ}\text{C}$; -31°F to $+173^{\circ}\text{F}$ (approx.). 	<ul style="list-style-type: none"> Leave the transceiver at room temperature for a while. Turn the power ON to check if the internal temperature has returned to normal. 	—
Self check error. (Battery voltage)	<ul style="list-style-type: none"> The connected battery pack's voltage is more than 11 V. 	<ul style="list-style-type: none"> Verify the battery voltage is correct. 	—
Transmitting continuously while not speaking when using VOX function.	<ul style="list-style-type: none"> Ambient noise is too loud. 	<ul style="list-style-type: none"> Remove the headset cable. Reduce the VOX gain setting. 	p. 14

12 SPECIFICATIONS

◇ GENERAL

- Frequency coverage
TX/RX : 156.300–156.875 MHz
- Mode : 16K0G3E
- Channel spacing : 25 kHz
- Power supply requirement : Battery packs (BP-234 or BP-224*)
*For on-board use only
- Current drain (approx.) : TX High (2 W) 1.0 A
at 7.5 V DC for [USA] TX Low (1 W) 700 mA
at 7.2 V DC for [GEN] Max. audio 200 mA
- Useable temperature range :
[USA] –20°C to +60°C; –4°F to +140°F
[GEN] –20°C to +55°C; –4°F to +131°F
- Antenna impedance : 50 Ω
- Dimensions : 65(W) × 145(H) × 44(D) mm
(Projections not included) 2^{9/16}(W) × 5^{23/32}(H) × 1^{3/4}(D) inch
- Weight (with BP-234) : Approx. 385 g (13.6 oz)

◇ TRANSMITTER

- Output power : 2 W (Hi) and 1 W (Low)
at 7.5 V DC for [USA]
at 7.2 V DC for [GEN]
- Modulation system : Variable reactance frequency modulation
- Frequency error :
[USA] ±5.0 ppm
(–20°C to +60°C; –4°F to +140°F)
[GEN] ±1.5 kHz
(–20°C to +55°C; –4°F to +131°F)
- Microphone impedance : 2 kΩ
- Max. frequency deviation : ±5.0 kHz
- Adjacent channel power : 70 dB
- Audio harmonics distortion : 10% at 60% deviation
- FM hum and noise : 40 dB

- Spurious emissions :
[USA] –70 dBc typical
[GEN] 0.25 μV (30 MHz to 1 GHz)
1 μV (1–2 GHz)

◇ RECEIVER

- Receive system : Double-conversion superheterodyne
- Sensitivity :
[USA] (at 12 dB SINAD) 0.25 μV typical
[GEN] (at 20 dB SINAD) –2 dBμ EMF typical
- Squelch sensitivity (at threshold) :
[USA] 0.35 μV typical
[GEN] –6 dBμ EMF typical
- Intermodulation rejection ratio :
[USA] 70 dB
[GEN] 68 dB
- Spurious response rejection ratio : 70 dB
- Adjacent channel selectivity : 70 dB
- Hum and noise : 40 dB
- Audio output power :
[USA] 0.35 W typical at 10% distortion with an 8 Ω load.
[GEN] 0.20 W at 10% distortion with an 8 Ω load.

All stated specifications are subject to change without notice or obligation.

◇ BATTERY PACKS

<FOR SURVIVAL CRAFT USE>

- **BP-234** LITHIUM BATTERY PACK
9.0 V/3300 mAh Lithium battery pack.

<FOR ON-BOARD USE>

- **BP-224** Ni-Cd BATTERY PACK
7.2 V/750 mAh Ni-Cd battery pack.
- **BP-225** Ni-Cd BATTERY PACK
7.2 V/1100 mAh Ni-Cd battery pack.

◇ BELT CLIPS

- **MB-103Y** BELT CLIP
The same as supplied with the transceiver.
- **MB-86** SWIVEL BELT CLIP
Belt clip for swivel type.
- **MB-96F/96N** BELT HANGER
 - ➔ MB-96F: Attaches with the supplied belt clip (Not swivel type).
 - ➔ MB-96N: Belt hanger for swivel type.

◇ OTHER OPTIONS

<FOR ON-BOARD USE ONLY>

- **HM-125** SPEAKER-MICROPHONE
Full sized waterproof (IPX7; 1 m; 3 ft depth for 30 min.) speaker-microphone. Includes an alligator clip to attach the speaker mic to your shirt or collar, etc.
- **HS-94/HS-95/HS-97** HEADSET + **OPC-1392** HEADSET ADAPTER
 - HS-94: Ear-piece type
 - HS-95: Neck-arm type
 - HS-97: Throat microphone

◇ CHARGERS <FOR ON-BOARD USE ONLY>

- **BC-119N** DESKTOP CHARGER + **AD-109** CHARGER ADAPTER
+ **BC-145A/E*** AC ADAPTER
For rapid charging of battery packs. An AC adapter is supplied with the charger depending on versions. Charging time: approx. 1.5 to 2 hours (BP-224).
- **BC-121N** MULTI-CHARGER + **AD-109** CHARGER ADAPTER (6 pcs.)
+ **BC-124** AC ADAPTER
For rapid charging of up to 6 battery packs (six AD-109 are required) simultaneously. An AC adapter should be purchased separately. Charging time: approx. 1.5 to 2 hours (BP-224).
- **BC-158** DESKTOP CHARGER + **BC-147A/E*** AC ADAPTER
Used for regular charging of battery pack. The same as supplied with the transceiver. Charging time: approx. 8 hours (BP-224).
*The supplied AC adapter is dependent on version.

◇ DC CABLES <FOR ON-BOARD USE ONLY>

- **CP-17L** CIGARETTE LIGHTER CABLE
Charges the battery pack through a 12 V cigarette lighter socket. (For BC-119N)
- **OPC-515L/OPC-656** DC POWER CABLES
Charges the battery pack using 13.8 V power source instead of the AC adapter.
OPC-515L: For BC-119N
OPC-656 : For BC-121N

Different versions of this radio use different options.
Ask your authorized dealers for details.

Count on us!

A-6383D-1EX-①
Printed in Japan
© 2004–2005 Icom Inc.

Icom Inc.
1-1-32 Kamiminami, Hirano-ku, Osaka 547-0003, Japan